

VSL POST-TENSIONING SOLUTIONS



CONCEPTUAL DESIGN
ENGINEERING SOLUTIONS
CONSTRUCTION PARTNER
FOR BRIDGES, BUILDINGS
CONTAINMENT
STRUCTURES, SLAB ON
GRADE, SPECIAL
STRUCTURES, REPAIR
AND STRENGTHENING

A REPUTATION FOR EXCELLENCE SINCE

VSL's leadership in post-tensioning

VSL is a recognised leader in the field of special construction methods. Well-proven technical systems and sound in-house engineering are the basis of the group's acknowledged reputation for innovative conceptual designs and engineering solutions, for reliability, quality and efficiency.



VSL executes all works using its own staff and equipment.



Gateway, Australia - 2008

VSL – post-tensioning as the core business

For decades, VSL has designed, manufactured and installed durable, state-of-the-art post-tensioning systems complying with international standards and approval guidelines for both new and existing structures. Services and products are all aimed at delivering the optimal solution for the customer.



Deep Bay Link, Hong Kong - 2005

The VSL Network

VSL operates as a multinational group of companies whose subsidiaries and licensees are organised into closely-cooperating regional units. Customers benefit greatly from the continuing development of VSL's special

construction methods and from the exchange of information taking place within the VSL Network.

VSL's aim of creating innovative solutions by adapting proven experience is supported by the ability to identify and share immediately the best ideas that have been introduced anywhere within the network. The solutions are developed and tailored for clients worldwide.

VSL Subsidiaries execute all work using their own personnel and equipment: technical consultancy and support during planning and all phases of construction are part of VSL's value-added service, which is tailored to suit the client's needs.

VSL – your construction partner

With offices throughout the world, VSL offers a comprehensive range of professional, high-quality services for all kinds of projects, from feasibility studies and preliminary designs to alternative proposals, contractor consultancy services and field installation. All are aimed at finding the best possible solutions with the best value for money. VSL's involvement seeks to provide fully-customised solutions adapted to the client's requirements. Its worldwide network allows VSL to offer a high degree of competence and flexibility, participating with a spirit of co-operation to find the most appropriate solutions. VSL's goal is to be a privileged partner for engineers and contractors.



Dubai Festival City, UAE - 2006

1956

Changing the way we do business

For VSL, sustainable development means striking a balance in its development model between the economic profitability of its businesses and their social and environmental impacts. That commitment is formalised into the VSL sustainable development program which focuses on safety, use of fewer scarce materials and less energy and production of less pollution and waste.

VSL – guided by a strong QSE culture

VSL's leading position is based on a rigorous and committed quality culture. The QSE (quality, safety, environment) policy is VSL's first priority. Local teams ensure co-ordination of actions, encourage sharing of experience and promote best practice, with the aim of continuously improving performance. In VSL's culture, employees are vitally important to the competitiveness and prosperity of the company. VSL is committed to maintaining the highest levels of client satisfaction and personnel safety.

CONTRIBUTING TO SUSTAINABLE SOLUTIONS

Post-tensioning reduces CO₂ emissions by up to 27%

Generally the use of VSL Post-tensioning delivers the maximum cost-benefit for a project as well as having a beneficial impact on its sustainability and CO₂ emissions during construction. Compared with conventional reinforced concrete slabs, the use of post-tensioning results in more durable structures with reduced concrete volumes, lowering the CO₂ emissions by up to 27%.

Post-tensioning offers significant reductions

Materials and quantities	RC (kg CO ₂ /m ²)	PC (kg CO ₂ /m ²)
Concrete (300 kg cement / m ³)	105.1	84.0
Reinforcing steel	24.8	8.3
Post-tensioning steel	0	3.0
Total CO ₂ emission	129.9	95.3

The overall reduction of CO₂ emission can achieve up to 27%!

RC: Reinforced concrete PC: Post-tensioned concrete



Ras Laffan LNG, Qatar - 1996

The VSL Academy

Competence is a key factor and VSL adopts a principle of continuous learning and training. Foremen, supervisors and site managers go through centralised training at the VSL Academy, where they learn best practice in all aspects of post-tensioning.



Barcelona New Exhibition Centre, Spain – 2008

VSL Post-Tensioning Systems

The VSL Post-Tensioning technology includes several systems that are specifically designed for different applications. The following table describes broadly these different systems and their main field of applications, which are thereon developed in this brochure.

APPLICATIONS	Monostrand and slab tendons		Multistrand tendons		Stressbar	
	Bonded	Unbonded	Internal	External	Internal	External
	<ul style="list-style-type: none"> • Slabs on grade • Building slabs • Transverse post-tensioning in bridge decks... 		<ul style="list-style-type: none"> • Longitudinal post-tensioning in bridges • Building frames • Containments • Special structures... 		<ul style="list-style-type: none"> • Short tendons, such as transverse post-tensioning for cable-stayed bridge pylons • Precast connections • Structural Strengthening... 	

R&D: THE KEY TO QUALITY AND DURABILITY

Research and development are VSL's driving force. The issues of QSE and sustainability have long been priorities together with the efficiency of construction methods and site works. This is

also the case for post-tensioning products and services where durability, monitoring and inspection are important to focus on, as too are competence in design and methods.

Traceability and site efficiency



ADAPT, the tool for Automatic Data Acquisition for Post-Tensioning, collects data about tendon forces and elongation during stressing. It uses a personal digital assistant (PDA) to process the information for further use by the client.



PT Observer uses barcode process technology to collect all data throughout the entire post-tensioning process, assuring traceability. VSL's PT Observer and ADAPT systems greatly enhance the quality of the operational process.

Adaptable and cost-saving solutions

The VSL AF Anchorage is used for vertical tendons, where the prestressing force is transferred to the structure at its lowest end and where there is no access.

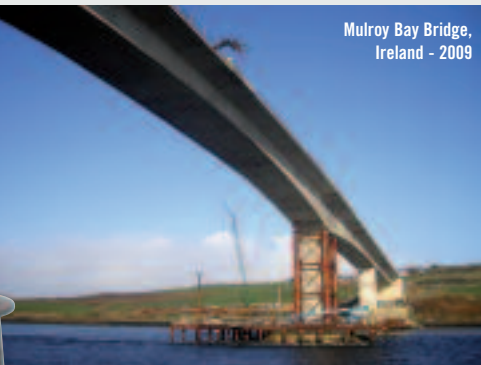
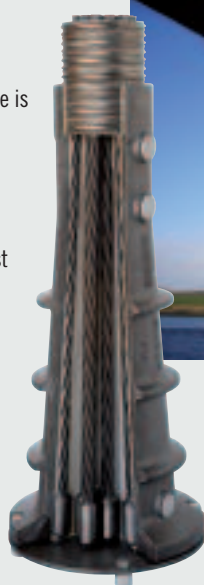

Mulroy Bay Bridge, Ireland - 2009

VSL develops custom-made specialised equipment such as movable scaffolding systems, launching girders, ... for bridge construction and has the in-house capabilities to customise them from one project to the next.

New solutions for enhanced durability

Leak-tight encapsulation with PT-PLUS®

VSL continuously drives durability development and markets its PT-PLUS® plastic duct system for leak-tight encapsulation and higher fatigue resistance.

Electrical isolation with VSL CS 2000



Together with the CS 2000 Anchorage, PT-PLUS® ducts produce electrically-isolated tendons (EIT) and allow monitoring of the effectiveness of the corrosion-protective encapsulation. The same principle had already been a success with a VSL world-first, the use of electrically isolated ground anchors on a project in 1985.

Void control with the VSL Grout Void Sensor

The VSL Grout Void Sensor is installed at potentially critical points on a tendon and checks for the existence of voids after grouting.



Load control with the VSL Single Strand Load Cell

The VSL-designed Single Strand Load Cell allows economical and precise measurement of the load on a strand. It is compact and easy to install, fitting onto any VSL Anchor Head.



TRAINING: AT THE HEART OF STRONG PERFORMANCE

VSL is committed to investing in its staff, setting up training schemes and striving for professionalism.

VSL Academy

VSL has launched the VSL Academy to strengthen the company culture and to develop knowledge sharing by formalising and standardising the training of all post-tensioning foremen, supervisors and site engineers.

The goals of the VSL Academy are to:

- provide a unique training facility and tools within VSL to train our personnel in the skill and techniques required to perform the work to the highest standards specified today;
- provide hands-on practical training on post-tensioning mock-ups designed to cover all operational procedures;
- harmonise working procedures and enhance knowledge.



PMX – training in project management excellence

The programme's content combines technical topics, planning, organisation, risk management and result orientation with communication topics and leadership. Through this, VSL's managers transfer the fundamentals and culture of the company while promoting exchanges and useful networking throughout the group.

On site training

As a specialist contractor, VSL aims to maintain and develop its staff's skills on a long-term basis. Senior staff members are in charge of teaching VSL Techniques to new recruits.

A well-trained staff is VSL's most valuable asset in providing the best-possible service to clients.

VSL Academy:
a market leader's initiative



VSL POST-TENSIONING SOLUTIONS FOR

Internal tendons – the most commonly-used solution

The VSL Systems are based on the method of post-tensioning. Most applications of the multi-strand system are internal and cement grouted, providing bond to the structure. Such tendons are extensively used in bridges and transportation structures as well as being applied successfully in building construction.

VSL's experience:
150,000 precast segments
forming 6.3 million m²
of bridge deck over
the last 20 years



VSL Post-Tensioning systems lead and shape the state-of-the-art in bridge construction. They meet the advanced technical and practical requirements of today's engineers and construction professionals they are versatile and provide clients with unmatched durability, with a choice of steel or VSL PT-PLUS® plastic duct, as well as the availability of technical and site expertise for fully-encapsulated and electrically-isolated tendons (EIT). The systems comply with national and international standards and are approved by EOTA (European Organisation for Technical Approvals) and by other approval bodies.

BRIDGES

External tendons for more flexibility

External post-tensioning tendons are positioned outside of the concrete section, though anchored into buttresses or diaphragms that form part of the bridge structure. They are therefore not bonded to the structure.

VSL External Post-Tensioning provides features such as the possibility of replacing tendons if required and easy inspection of the integrity of the corrosion protection. Applications are not restricted to concrete, but also include structural

East Tsing Yi Viaduct, Hong Kong - 2009

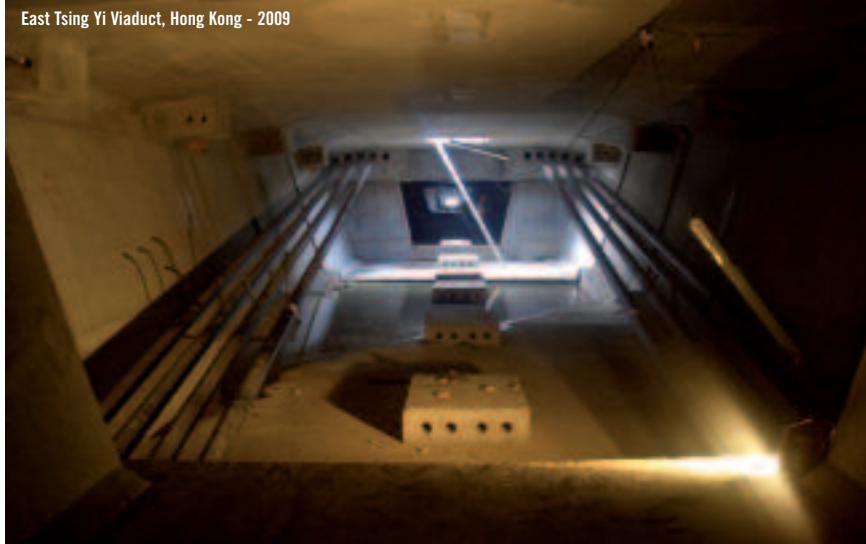

Boulonnais Viaduct, France - 1996

Gautrain Rapid Rail Link, South Africa - 2009



Brunswick Head, Australia - 2006

steel, composite steel-concrete bridges, timber and masonry structures. The external tendon technology has been used for bridge superstructures, girders in buildings and roof structures as well as for circular structures such as silos and reservoirs.



Medway Crossing Bridge, UK - 2001

External post-tensioning tendons can also be installed after completion of a structure if additional load capacity is required. This is done by adding tendons to the structure if the original design and construction were made to accommodate such an addition. Otherwise, a retrofit method can be implemented, although this requires a high level of engineering for structural analysis.

VSL POST-TENSIONING SOLUTIONS FOR BRIDGES

VSL Post-tensioning – a tool for pushing the limits

Bridge construction without post-tensioning is unthinkable. It is even a prerequisite for most of today's methods and allows the fast bridging of large spans with aesthetically-pleasing results. VSL's competence is outstanding in all known bridge construction methods. It is unrivalled in precast segmental construction, a method particularly suited to building large structures rapidly and economically even and especially into congested urban environments.

VSL as your “know-how partner”

VSL's post-tensioning know-how originates from thousands of projects and starts with a fundamental understanding of economically-optimised bridge concepts. With its design and methodology teams, VSL provides engineers and contractors with expertise in building cost-effective, durable and tailored structures.



INCREMENTAL LAUNCHING METHOD

Sagarra-Garrigues water channel, Spain - 2008



BALANCED CANTILEVER CAST-IN-SITU

Gateway bridge upgrade, Australia - 2008



ERECTION BY LIFTING FRAME

West Tsing Yi Viaduct, Hong Kong - 2004



ERECTION BY OVERHEAD GANTRY

Metro de Santiago, Chile - 2005



ERECTION BY UNDERSLUNG GANTRY

Windsor Floor Plane Project, Australia - 2006

ENHANCING DURABILITY

Gaining something extra with VSL's PT-PLUS® duct system

For conventional applications in non-aggressive environment, corrugated steel ducts are normally used. However, the corrugated plastic ducts and plastic couplers of the VSL PT-PLUS® system provide important advantages when compared with conventional steel ducts, including tight encapsulation, high fatigue resistance and a low friction coefficient. For details see page 22.



A new coupler for EIT in precast structures

A new plastic coupler now permits full tendon encapsulation or EIT protection at the joints of precast segmental structures. The coupler is compact and similar in size to the ducting and can be used when tendons cross the segment at an angle.

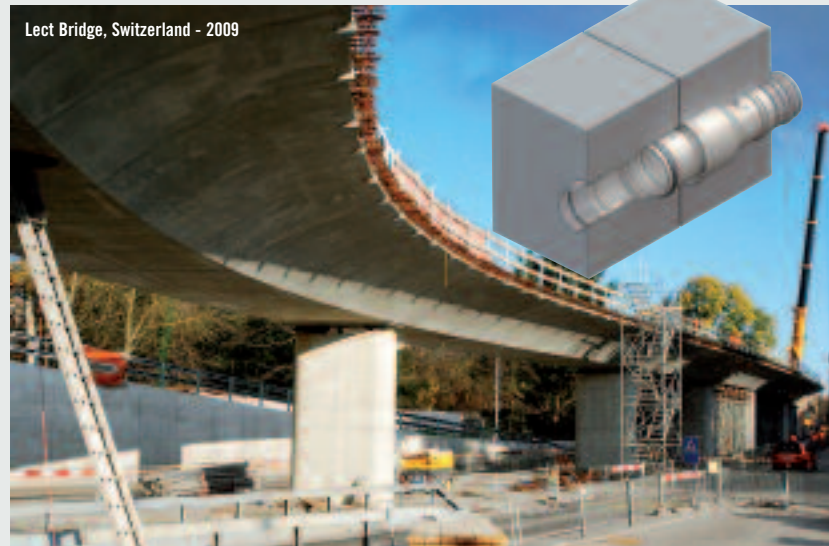

Enhancing durability – VSL's concept for multi-layer protection

The multi-layer corrosion protection system enhances durability. It combines a careful overall concept and design of the structure's waterproof membranes, low-permeability concrete and leak-tight tendon encapsulation with a cementitious grout or other protection systems.

VSL is well qualified to assist decision makers with the adequate service when crucial protection strategies and measures are evaluated and decided.

The tendon encapsulation - the decisive choice

Bearing in mind *fib's* bulletin 33 and given the specific characteristics of PT-PLUS®, the following is recommended:

PL 1: using corrugated metal duct with special high quality grout (e.g. VSL's HPI Grouting). Cement grout provides excellent protection however grouting is a task for specialists. As an experienced specialist contractor, VSL carries out high-quality grouting using trained personnel and reliable equipment and in accordance with well proven procedures. In addition, VSL recommends the use of vacuum-assisted grouting for the most challenging conditions, such as where high

points are not accessible or in other special cases. VSL provides a full service for this state-of-the-art technique.

PL 2: using PT-PLUS® ducts as leak tight encapsulation for enhanced protection against corrosion and fatigue, this is particularly suited

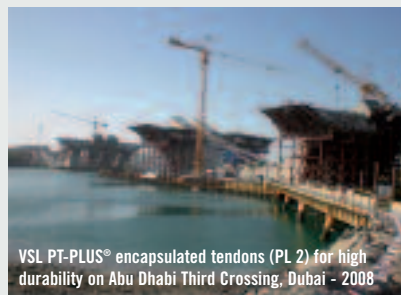

for transverse tendons in bridge deck slabs and other structures where tendons are close to the concrete surface and subjected to fatigue; generally structures in severe corrosion environment and to bridges and other structures with fatigue loadings.

PL 3: allowing monitoring of the integrity of tendon encapsulation including protection against stray currents, applying the Electrical Isolation Tendon (EIT) method with PT-PLUS® ducts and the appropriate VSL Anchorage. VSL's grout void sensors enhance quality monitoring during grouting of tendons.

PL = Protection Level

VSL POST-TENSIONING IN BUILDINGS - A TOOL TO ACHIEVE SUBSTANTIAL BENEFITS



Kens Project,
Australia - 2004

Architects have:

- more aesthetic freedom and larger column-free spaces that generate more flexibility for offices, shopping centres, warehouses, car parks and similar structures.

Contractors gain through:

- shorter construction time as formwork is often simpler and due to lesser back-propping;
- reduced cycle times as post-tensioning allows the structure to be stripped earlier leading to an overall reduction in the construction programme;
- fast and easy installation of electric, air conditioning and other services for flat slabs;
- less energy consumption.

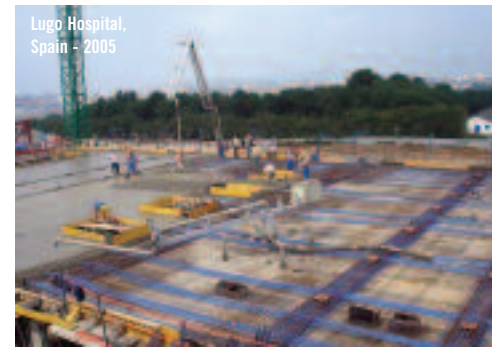

Lugo Hospital,
Spain - 2005



WHotel, USA - 2006



B2B Hotel, Mexico - 2008

Considerable savings for all parties

The advantages of using post-tensioning in buildings are being exploited in many countries and acknowledged by all partners in the construction process.

Owners benefit from:

- savings in materials in structures and foundations, leading to more economical construction;
- reduced financing costs due to shorter construction periods;
- less need for maintenance because of the crack and vibration control;
- more useable space within the available height limits;
- reduced deflection of structures.

VSL's experience of economical applications:

- post-tensioned slabs for all types of buildings, parking structures and warehouses;
- post-tensioned transfer beams and transfer plates to provide spacious, column-free, architecturally pleasing spaces such as entrance halls, lobbies and convention rooms;
- post-tensioned raft foundations resulting in more economical solutions with improved deflection behaviour and better shear soil pressure distribution;
- post-tensioned concrete walls such as cores and masonry walls, allowing the architect and engineer to design with more flexibility and pleasing aesthetics;

FITS

- post-tensioning in structural members such as the mega-trusses of high-rise buildings to withstand wind-generated overturning moments.

VSL Post-tensioning Services – providing a solid frame for any structure

VSL's scope of services goes beyond the supply of components and includes:

- design assistance at the conceptual stage to select the best option for the floor system and provide preliminary sizing and quantities;

Burj Residence Dubai, UAE - 2007



- assistance in all detailed design stages with a constant aim of optimising savings in materials, achieving sustainability of the structure and easing construction to reduce the cycle times and the resources required;
- all works for the supply and installation of the post-tensioning materials, including a turnkey service package provided by VSL's site teams.

VSL's experience: Millions of square metres designed and built throughout the world over the past 50 years

Detailed information is given in VSL's "Post-tensioning in building" publication (Report Series 4.1 and 4.2).

APPLICATIONS



FRAME CONSTRUCTION

Venetian Macao Resort Hotel, China - 2007
Frame construction for speed and ease of building with large open spaces or heavy loads.



SLAB CONSTRUCTION

RCBC Plaza, Philippines - 2000
VSL Post-Tensioning allows thinner slabs or larger spans.

MEGA-TRUSSES

International Commerce Centre, Hong Kong - 2008
VSL Post-Tensioning is often part of major structures such as this 480m-tall skyscraper, which is stabilised against typhoon winds through the use of post-tensioned mega-trusses that link the external columns to the inner core of the building.



TRANSFER PLATE/BEAMS CONSTRUCTION

Liverpool Tower, UK - 2006
Accommodating different floor layouts to ensure proper load transfer.



VSL POST-TENSIONING: IDEALLY SUITED

Unique VSL Anchorages for economical solutions

The shapes and functions of containment structures make them ideally suited to post-tensioning. Well-designed structures are practically crack-free and, most importantly, they are economical.



Boyer Tank,
Australia - 2008



Water tank,
Cote d'Ivoire - 2008



N'Kossa Barge,
France - 1995

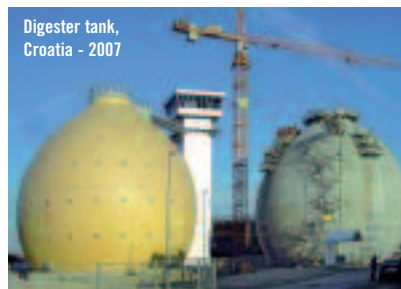

Digester tank,
Croatia - 2007



AF anchorages



L anchorage



Z anchorage

Thanks to the variety of its post-tensioning anchorage systems, VSL offers versatile solutions for engineers and contractors to optimise costs and construction times. Some of the well-known VSL Anchorages are particularly suited for use in containment structures:

- The patented AF anchorage, which is used as the lower non-stressing anchorage for vertical tendons that are not accessible during strand installation and stressing;
- The L anchorage, which is used as the lower non-stressing anchorage for vertical tendons and allows the strand bundle to be pushed or pulled through and stressed after the concrete work for the wall has been finished;
- The Z anchorage, which is normally used for hoop tendons that can be installed within the wall thickness and which therefore do not necessitate buttresses for the stressing operation.



ICM Corn Silo,
USA - 2008

TO CONTAINMENT STRUCTURES



Ulsan Nuclear Power Plant, Korea - 2005

Meeting stringent requirements with exceptional reliability

Some applications are extraordinary and call for additional measures and special testing:

Nuclear applications

VSL carried out comprehensive tests on a full-scale mock-up of the latest generation of nuclear power plants to verify compliance of its PT systems and methods with new specific requirements. The purpose-built ring structure in Gien, France, has a radius of 24.46m and a height of 2.75m. VSL demonstrated that its systems, equipment and procedures meet the stringent requirements for installation,

stressing and grouting operations on various types of tendons forming full 360° circle.

Liquefied gas applications

The construction of tanks for LNG and LPG (liquefied natural and petroleum gas) requires cryogenic testing of the post-tensioned tendons. During these tests, strands and anchorages are subjected to temperatures down to -196°C and are tested according to ETAG or other international standards. Through its long experience and proven post-tensioning systems, VSL is in a position to supply its post-tensioning systems to any LNG or LPG project around the globe.

Two units LAES-2 Nuclear Power Station in St Petersburg, Russia.

The VSL System with 55 greased and sheathed 0.6" strands is used for the 67.7m high inner of the two containment shells. 76 hoop tendons anchored in one of the two buttresses, 13 extra tendons in the dome, as well as 50 vertical over-the-dome tendons stressed from a stressing gallery are post-tensioned according to the latest nuclear containment requirements. The system allows checking the residual load, retensioning or replacing the tendons.

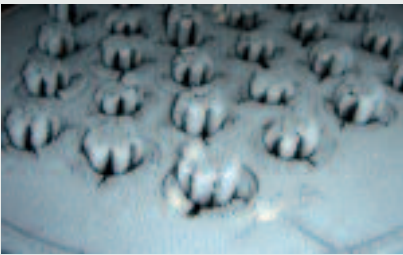
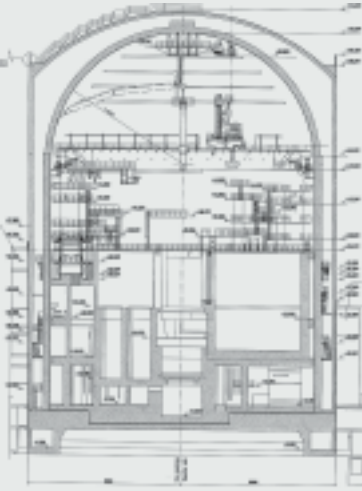

EXTREME TEMPERATURE TESTING

Anchorage and tendons tested at temperatures down to -196°C

Shanghai LNG Tank, China - 2007-2009



VSL POST-TENSIONING FOR SLAB ON GRADE CONSTRUCTION: THE COST-EFFECTIVE SOLUTION



Benefits to the owner

Elimination of joints: Owners and operators benefit from the elimination of all or most of the costly joints, when using post-tensioned slab on grade.

Shorter construction time: Compared with ordinary reinforced concrete slabs, the use of VSL's technologies leads to less excavation, a thinner slab, little or no reinforcement and few if any joints. Large areas in excess of 2,500m² can be concreted, which results in a shorter construction time and contributes to a very competitive initial cost.

"Crack free" performance: Initial stressing can prevent shrinkage cracking. Post-tensioning compresses the slab and counteracts tensile stresses that would otherwise cause cracking under the worst combinations of loads or in poor soil conditions.

High impact and abrasion resistance: The compression resulting from post-tensioning combined with an optimum concrete strength and surface treatment reduces general wear and tear and subsequent maintenance costs.

Low maintenance: The significant reduction in the number of joints means that less maintenance is required, giving great improvements in operational efficiency.

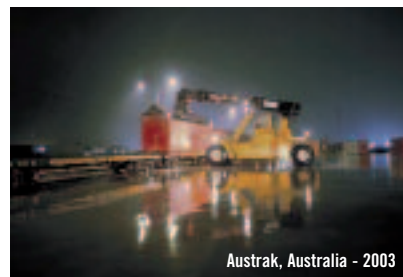

Large slabs, indoor or outdoor

VSL Post-tensioning is widely used in the construction of pavement areas and in slabs on grade, where a concrete slab foundation is placed directly on the ground. Its advantages provide benefits in many different types of projects including warehouses, distribution centres, container storage terminals, rail and shipping terminals, airports, manufacturing facilities and as floor bases for liquid retaining structures. Post-tensioned slabs are also used for residential purposes and in recreation, such as for tennis courts and skating rinks. VSL can provide the full range of services from the installation of post-tensioning to the complete design and construction of the concrete slab.



The 30,000m² of joint-free slab of the Nestlé Plant constructed by VSL Chile represents the present world record.

VSL POST-TENSIONING FOR SPECIAL STRUCTURES: A SMART ALTERNATIVE

PIPELINE CONSTRUCTION

Sea water pipeline, Morocco - 2007

This 2km-long pipeline south of Casablanca has an internal diameter of 2.5m with a 300mm-thick wall. Structural integrity and water-tightness is provided by transverse post-tensioning using sheathed monostrand with an average of three loops and longitudinal tendons 12 0.6" strands of 100m length.

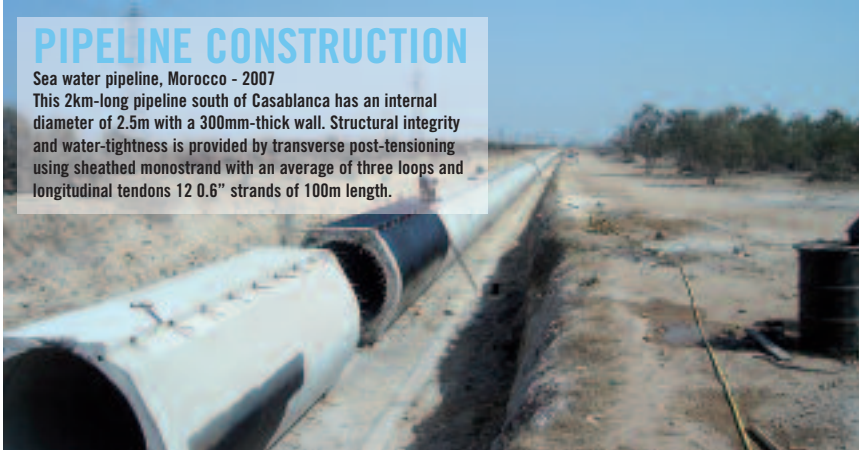

Versatile applications

Without post-tensioning, many special structures could only be built with great effort, if indeed they could be built at all. Over the years, VSL's post-tensioning services have been used for a very wide range of highly prestigious and complex structures including offshore platforms, concrete floating barges, dams and many others. Customers value the experience and versatility they gain by having VSL as a partner from the early planning stages through to construction.



STADIUM CONSTRUCTION

José Alvalade Stadium, Portugal - 2004

The challenge of building a multifunctional stadium with two halls that are part of irregular and complicated structural elements is an excellent example of a project where clients can benefit from the versatility of VSL as a professional post-tensioning partner.

SUB-STRUCTURE CONSTRUCTION

Machang Bridge, Korea - 2006

The cable-stayed Machang Bridge crosses the neck of the Masan Bay. Post-tensioning tendons with VSL Loop Anchorages were installed for the deck-to-pile footing tie-down system in the piers supporting the bridge's back spans.



TUNNEL CONSTRUCTION - WHETHER HYDROSTATIC PRESSURE PUSHES FROM...

...INSIDE

Thun Bypass Tunnel, Switzerland - 2008

A 1.2km-long tunnel of 5.4m diameter was built to increase the discharge from Lake Thun. The prevailing pressure conditions led to the use of a 1.2m-wide lining segment that was post-tensioned with two tendons, each with two 0.5" monostrands encapsulated in plastic ducts. VSL Switzerland was fully involved in the planning and conceptual phase of the post-tensioning tendon details.

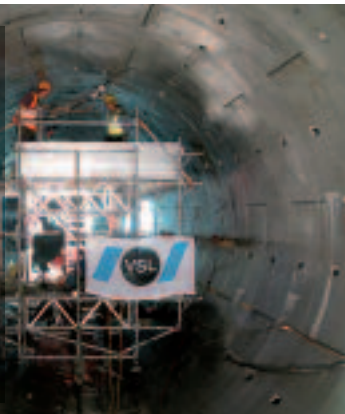

...OR OUTSIDE

Thu Thiem Immersed Tunnel, Vietnam - 2008/2009

The tunnel crosses under the Saigon River in Ho Chi Minh City and is made up of four precast tunnel units, each 33m wide, 9m high and 90m long. The elements are post-tensioned longitudinally with 6-12 tendons, then sealed at both ends, floated, towed to site and sunk. VSL also carried out the design, supply and erection of four sets of formwork to cast 15m-long segments.

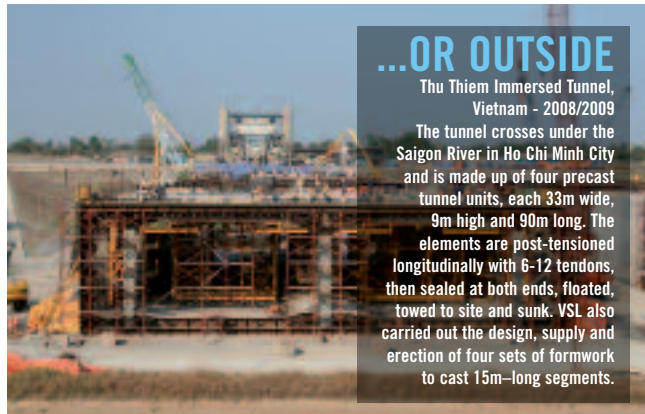

VSL POST-TENSIONING FOR REPAIR WORK A MUST FOR TAILOR-MADE SOLUTIONS

Structural remedial work requires thorough diagnosis of damage and deterioration followed by full assessment of the causes, risks and consequences involved.

VSL employs state-of-the-art equipment and special inspection techniques to detect defects in reinforced and prestressed concrete structures before any significant damage occurs. Close co-operation with materials testing institutes and structural designers, together with the use of the latest investigation techniques, enables VSL to prepare precise and comprehensive reports.

Assessment diagnosis of structural conditions includes:

- inspection and surveillance of concrete structures;
- condition evaluation of the same;
- root cause analysis;
- design of repair strategies;
- estimating the order of magnitude for the cost of repairs.



REPLACEMENT OF EXTERNAL POST-TENSIONING IN BRIDGES

St Cloud Viaduct, France - 2000

The external tendons that reinforced the 1974-built 1,102m-long Saint Cloud Bridge between Paris and Normandy showed signs of corrosion and the client decided to replace them. As a first precautionary step, shock-absorbers were fitted at each side of the deviators before the tendons were cut and the anchorages removed or adapted. New external tendons were then installed by VSL.



REPAIR OF BRIDGES

Figueira de Foz Bridge, Portugal - 2005

VSL Portugal, in partnership with a local contractor, carried out repair works including external post-tensioning, strengthening of the abutments with bars and replacement of expansion joints. There was also retrofitting of structural bearings and seismic devices, including the installation of 4 x 500kN shock-absorbers at the abutments.

STRENGTHENING OF HISTORICAL BUILDINGS

“Las Arenas” Bullfighting Ring, Spain - 2007

One of the many examples in Barcelona where VSL has assisted with engineering and specialised site works is this former bull ring, built in 1898, which has been transformed into a leisure and entertainment complex. VSL carried out engineering and post-tensioning works in connection with the transfer slab and beams of the Neo-Mudéjar façade. The project involved post-tensioned floors with spans of between 12m and 17m and the supply of other VSL products such as neoprene bearings and studs.



The Leaning Tower of Pisa, Italy - 1993

VSL strengthened the world-renowned Leaning Tower of Pisa with 18 specially-developed monostrand hoop tendons. The optimum solution consisted of a marble-coloured PE-sheath and galvanized, non-greased 0.6" strand with a centre stressing anchorage, allowing force adjustment and monitoring during and after the stressing operation.



STRENGTHENING OF A NUCLEAR POWER PLANT

Gösgen Nuclear Power Plant, Switzerland - 2005

A carbon fibre tendon system was used for the seismic upgrade of the emergency feed building at the Gösgen nuclear power plant. The system consists of carbon CFRP plates and head and is well suited for seismic and other strengthening measures where post-tensioning forces are needed in very thin tensile members.



SILO REPAIR AND STRENGTHENING

Blue Circle Cement Silo, Singapore - 2001

The 60m-tall silo was strengthened using a VSL-engineered solution of externally wrapped, bonded tendons each with four strands of 0.6". The 66 tendons are encapsulated in flat high-density polyethylene ducts and anchored into special stressing brackets.

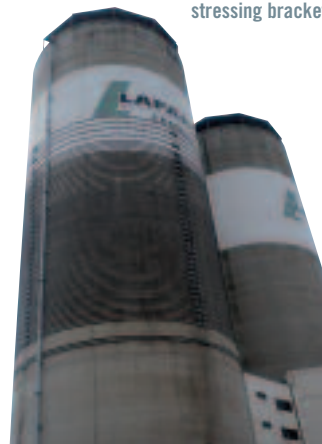

VSL's other repair solutions

VSL also provides other structural solutions for the repair and strengthening of structures including:

- passive strengthening with the design and application of:
 - bonded CFRP (carbon fibre reinforced polymer);
 - bonded SRP (steel reinforced polymer).
- protection with:
 - Ductal®, the ultra-high-strength and ductile blast-resistant solution;
 - dampers for mitigation of vibration induced by earthquake, wind and human activities;
 - cathodic protection for corrosion mitigation.

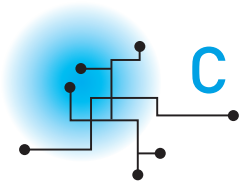

CREATING SOLUTIONS TOGETHER

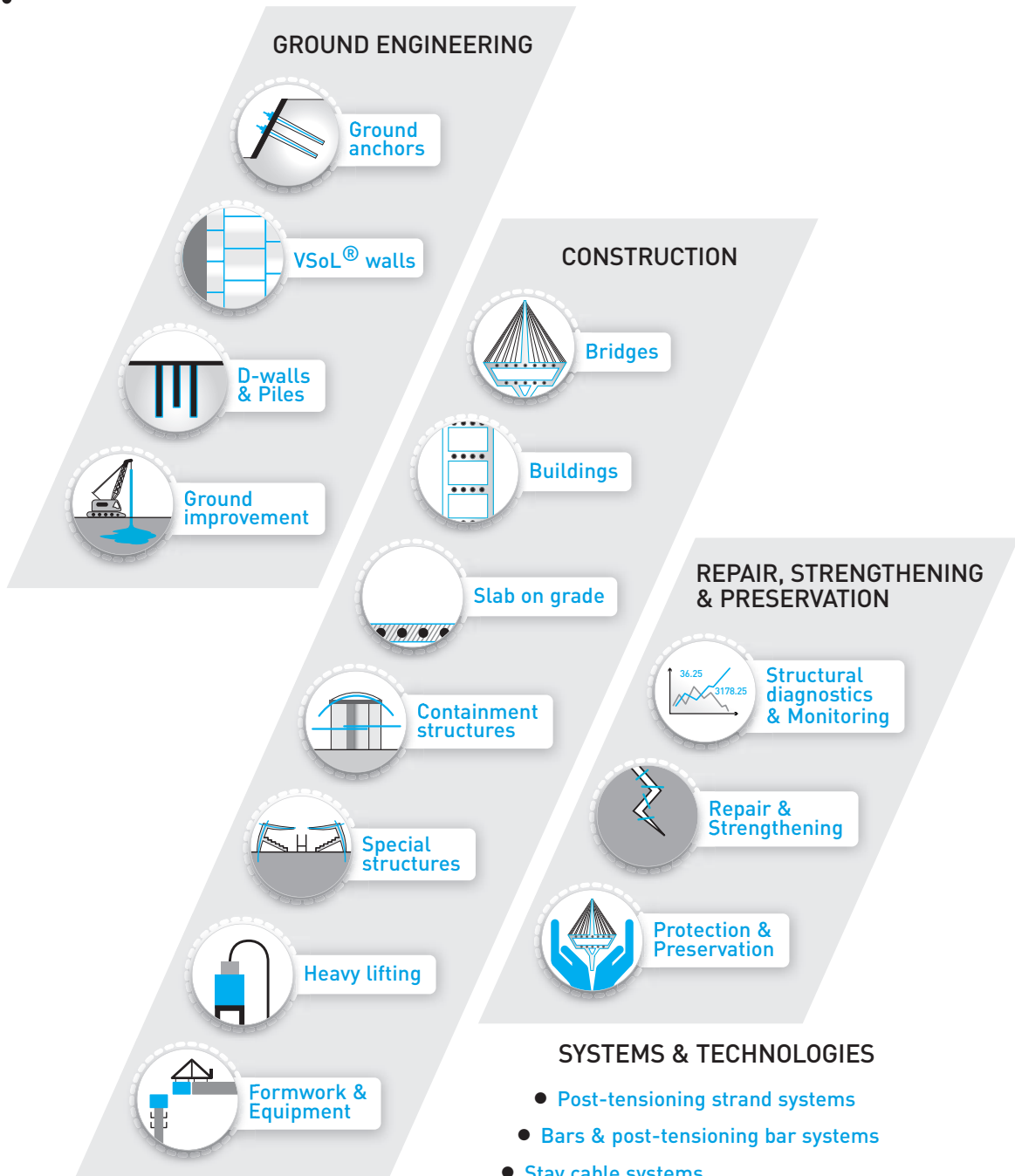

www.vsl.com

VSL TECHNICAL DATA AND DESIGN CONSIDERATIONS



STRAND AND TENDON PROPERTIES
PT-PLUS® DUCT SYSTEM DATA
TENDON LAYOUT, RADII, FRICTION AND TENDON
LOSSES FOR INTERNAL AND EXTERNAL CABLES
BLOCK-OUTS AND EQUIPMENT DATA

1 - STRAND

1.1 - STRAND PROPERTIES 13mm (0.5")

Strand type		prEN 10138 – 3 (2006) Y1860S7		ASTM A 416-06 Grade 270
Nominal diameter	d (mm)	12.5	12.9	12.7
Nominal cross section	A _p (mm ²)	93	100	98.7
Nominal mass	M (kg/m)	0.726	0.781	0.775
Nominal yield strength	f _{p0,1k} (MPa)	1634 ¹	1640 ¹	1675 ²
Nominal tensile strength	f _{pk} (MPa)	1860	1860	1860
Specif./min. breaking load	F _{pk} (kN)	173	186	183.7
Young's modulus	(GPa)	approx. 195		
Relaxation ³ after 1000 h at 20°C and 0.7 x F _{pk}	(%)	max. 2.5		

1) Characteristic value measured at 0.1% permanent extension

2) Minimum load at 1% extension for low-relaxation strand

3) Valid for relaxation class acc. to prEN 10138-3 or low-relaxation grade acc. to ASTM A 416-06

1.2 - TENDON PROPERTIES 13mm (0.5")

Unit	Strands numbers	Steel area		Breaking load			Corrugated steel duct ³ (recommended)		Corrugated plastic duct VSL PT-PLUS®		Steel pipes Ø ext x t	
		A _p acc. to prEN		ASTM	Y1860S7 (prEN)		Grade 270 (ASTM)	Ø _i / Ø _e	e	Ø _i / Ø _e		e
		d=12.5 mm A _p =93 mm ²	d=12.9 mm A _p =100 mm ²	d=12.7 mm A _p =100 mm ²	d=12.5 mm A _p =93 mm ²	d=12.9 mm A _p =100 mm ²	d=12.7 mm A _p =98.7 mm ²	[mm]	[mm]	[mm]		[mm]
		[mm ²]	[mm ²]	[mm ²]	[kN]	[kN]	[kN]				[mm]	
5-1	1	93	100	98.7	173	186	183.7	20/25	3	22/25	6	25.0 x 2.0
5-2	2	186	200	197	346	372	367	35/40	8	76/25 ²	-	31.8 x 2.0/2.5/3.0
5-3	3	279	300	296	519	558	551	35/40	6	76/25 ²	-	33.7 x 2.0/2.5/3.0
5-4	4	372	400	395	692	744	735	40/45 ¹	7	76/25 ²	-	42.4 x 2.0/2.5/3.0
5-7	5	465	500	494	865	930	919	45/50	8	58/63	14	60.3 x 2.0/2.5/3.0
	6	558	600	592	1038	1116	1102	45/50	6	58/63	12	
5-7	7	651	700	691	1211	1302	1286	50/57	7	58/63	11	60.3 x 2.0/2.5/3.0
5-12	8	744	800	790	1384	1488	1470	55/62	9	58/63	10	70.0 x 2.0/2.5/3.0
	9	837	900	888	1557	1674	1653	55/62	8	58/63	9	
	10	930	1000	987	1730	1860	1837	60/67	10	58/63	9	
	11	1023	1100	1086	1903	2046	2021	60/67	9	58/63	8	
5-12	12	1116	1200	1184	2076	2232	2204	60/67	8	58/63	7	70.0 x 2.0/2.5/3.0
5-15	13	1209	1300	1283	2249	2418	2388	65/72	9	76/81	14	82.5 x 2.0/2.5/3.0
	14	1302	1400	1382	2422	2604	2572	65/72	8	76/81	13	
5-15	15	1395	1500	1481	2595	2790	2756	70/77	9	76/81	12	82.5 x 2.0/2.5/3.0
5-19	16	1488	1600	1579	2768	2976	2939	70/77	9	76/81	12	88.9 x 2.5/3.0/3.5
	17	1581	1700	1678	2941	3162	3123	75/82	11	76/81	11	
	18	1674	1800	1777	3114	3348	3307	75/82	10	76/81	10	
5-19	19	1767	1900	1875	3287	3534	3490	75/82	9	76/81	9	88.9 x 2.5/3.0/3.5
5-22	20	1860	2000	1974	3460	3720	3674	80/87	10	100/106	20	88.9 x 2.5/3.0/3.5
	21	1953	2100	2073	3633	3906	3858	80/87	9	100/106	19	
5-22	22	2046	2200	2171	3806	4092	4041	80/87	8	100/106	18	88.9 x 2.5/3.0/3.5
5-27	23	2139	2300	2270	3979	4278	4225	85/92	12	100/106	19	101.6 x 3.0/4.0/5.0
	24	2232	2400	2369	4152	4464	4409	85/92	11	100/106	18	
	25	2325	2500	2468	4325	4650	4593	90/97	14	100/106	19	
	26	2418	2600	2566	4498	4836	4776	90/97	13	100/106	18	
5-27	27	2511	2700	2665	4671	5022	4960	95/102	15	100/106	17	101.6 x 3.0/4.0/5.0
5-31	28	2604	2800	2764	4844	5208	5144	95/102	14	100/106	16	108.0 x 3.0/4.0/5.0
	29	2697	2900	2862	5017	5394	5327	95/102	13	100/106	15	
	30	2790	3000	2961	5190	5580	5511	95/102	12	100/106	14	
5-31	31	2883	3100	3060	5363	5766	5695	95/102	11	100/106	13	108.0 x 3.0/4.0/5.0
5-37	32	2976	3200	3158	5536	5952	5878	100/107	13	115/121	20	114.3 x 3.0/4.0/5.0
	33	3069	3300	3257	5709	6138	6062	100/107	12	115/121	19	
	34	3162	3400	3356	5882	6324	6246	100/107	12	115/121	19	
	35	3255	3500	3455	6055	6510	6430	110/117	17	115/121	19	
	36	3348	3600	3553	6228	6696	6613	110/117	17	115/121	19	
5-37	37	3441	3700	3652	6401	6882	6797	110/117	16	115/121	18	114.3 x 3.0/4.0/5.0
5-43	43	3999	4300	4244	7439	7998	7899	120/127	18	130/136	23	127.0 x 3.0/4.0/5.0
5-55	55	5115	5500	5429	9515	10230	10104	130/137	17	130/136	17	139.7 x 3.0/4.0/5.0

1) Flat ducts possible as well

2) Flat duct PT-PLUS with rectangular slab anchorages, for PT-PLUS see also under 3.1.3.

3) If flat ducts (steel or PT PLUS) to be used with square type castings please contact your VSL representative. In plan view, tendons with slab type anchorages must be straight between anchorages or have only unidirectional turns with min. radii of > 6 m. Strands must always be pushed-in prior to concreting. Eccentricity e: negligible

4) Given values may slightly vary depending on local availability of ducts. They are minimal for most applications. For special cases (long tendons, many curvatures, small radii etc.) greater size duct is recommended – please verify with VSL. In any case the filling ratio (cross-section steel / duct) must not exceed 0.5 (EN523).

5) Please check with the nearest VSL office for the complete anchorage list

1.3 - STRAND PROPERTIES 15mm (0.6")

Strand type			prEN 10138 – 3 (2006) Y1860S7		ASTM A 416-06 Grade 270
	Nominal diameter	d	(mm)	15.3	15.7
Nominal cross section	A _p	(mm ²)	140	150	140
Nominal mass	M	(kg/m)	1.093	1.172	1.102
Nominal yield strength	f _{p0.1k}	(MPa)	1636 ¹	1640 ¹	1676 ²
Nominal tensile strength	f _{pk}	(MPa)	1860	1860	1860
Specif./min. breaking load	F _{pk}	(kN)	260	279	260.7
Young's modulus	(GPa)		approx. 195		
Relaxation ³ after 1000 h at 20°C and 0.7 x F _{pk}	(%)		max. 2.5		

1) Characteristic value measured at 0.1% permanent extension

2) Minimum load at 1% extension for low-relaxation strand

3) Valid for relaxation class acc. to prEN 10138-3 or low-relaxation grade acc. to ASTM A 416-06

1.4 - TENDON PROPERTIES 15mm (0.6")

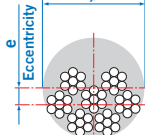
Unit	Strands numbers	Steel area			Breaking load			Corrugated steel duct ¹ (recommended)		Corrugated plastic duct VSL PT-PLUS [®]		Steel pipes
		A _p acc. to prEN		ASTM	Y1860S7 (prEN)		Grade 270 (ASTM)	Ø _i / Ø _e	e	Ø _i / Ø _e	e	
		d=15.3 mm A _p =140 mm ²	d=15.7 mm A _p =150 mm ²	d=15.24 mm A _p =140 mm ²	d=15.3 mm A _p =140 mm ²	d=15.7 mm A _p =150 mm ²	d=15.24 mm A _p =140 mm ²	[mm]	[mm]	[mm]	[mm]	
		[mm ²]	[mm ²]	[mm ²]	[kN]	[kN]	[kN]					[mm]
6-1	1	140	150	140	260	279	260.7	25/30	5	23/25	4	25.0 x 2.0
6-2	2	280	300	280	520	558	521	40/45	9	76/25 ⁴	-	33.7 x 2.0/2.5/3.0
6-3	3	420	450	420	780	837	782	40/45	6	76/25 ⁴	-	42.4 x 2.0/2.5/3.0
6-4	4	560	600	560	1040	1116	1043	45/50	7	76/25 ⁴	-	48.3 x 2.0/2.5/3.0
6-7	5	700	750	700	1300	1395	1304	50/57	8	58/63	13	76.1 x 2.0/2.5/3.0
	6	840	900	840	1560	1674	1564	55/62	9	58/63	11	
6-7	7	980	1050	980	1820	1953	1825	55/62	7	58/63	9	76.1 x 2.0/2.5/3.0
6-12	8	1120	1200	1120	2080	2232	2086	65/72	11	76/81	18	80.0 x 2.0/2.5
	9	1260	1350	1260	2340	2511	2346	65/72	9	76/81	16	
	10	1400	1500	1400	2600	2790	2607	70/77	11	76/81	15	
	11	1540	1650	1540	2860	3069	2868	70/77	9	76/81	13	
6-12	12	1680	1800	1680	3120	3348	3128	75/82	11	76/81	12	80.0 x 2.0/2.5
6-15	13	1820	1950	1820	3380	3627	3389	80/87	13	100/106	25	101.6 x 3.0/4.0/5.0
	14	1960	2100	1960	3640	3906	3650	80/87	11	100/106	24	
6-15	15	2100	2250	2100	3900	4185	3911	80/87	10	100/106	23	101.6 x 3.0/4.0/5.0
6-19	16	2240	2400	2240	4160	4464	4171	85/92	12	100/106	22	101.6 x 3.0/4.0/5.0
	17	2380	2550	2380	4420	4743	4432	85/92	11	100/106	20	
	18	2520	2700	2520	4680	5022	4693	90/97	13	100/106	19	
6-19	19	2660	2850	2660	4940	5301	4953	90/97	12	100/106	18	101.6 x 3.0/4.0/5.0
6-22	20	2800	3000	2800	5200	5580	5214	100/107	17	100/106	17	114.3 x 3.0/4.0/5.0
	21	2940	3150	2940	5460	5859	5475	100/107	16	100/106	16	
6-22	22	3080	3300	3080	5720	6138	5735	100/107	15	100/106	15	114.3 x 3.0/4.0/5.0
6-27	23	3220	3450	3220	5980	6417	5996	100/107	14	115/121	22	114.3 x 3.0/4.0/5.0
	24	3360	3600	3360	6240	6696	6257	100/107	13	115/121	22	
	25	3500	3750	3500	6500	6975	6518	110/117	18	115/121	21	
	26	3640	3900	3640	6760	7254	6778	110/117	17	115/121	21	
6-27	27	3780	4050	3780	7020	7533	7039	110/117	16	115/121	20	114.3 x 3.0/4.0/5.0
6-31	28	3920	4200	3920	7280	7812	7300	110/117	15	130/136	27	127.0 x 3.0/4.0/5.0
	29	4060	4350	4060	7540	8091	7560	120/127	21	130/136	27	
	30	4200	4500	4200	7800	8370	7821	120/127	20	130/136	26	
6-31	31	4340	4650	4340	8060	8649	8082	120/127	19	130/136	25	127.0 x 3.0/4.0/5.0
6-37	32	4480	4800	4480	8320	8928	8342	120/127	18	130/136	24	139.7 x 3.0/4.0
	33	4620	4950	4620	8580	9207	8603	120/127	17	130/136	23	
	34	4760	5100	4760	8840	9486	8864	120/127	16	130/136	22	
	35	4900	5250	4900	9100	9765	9125	130/137	22	130/136	22	
	36	5040	5400	5040	9360	10044	9385	130/137	21	130/136	21	
6-37	37	5180	5550	5180	9620	10323	9646	130/137	20	130/136	20	139.7 x 3.0/4.0
6-43	43	6020	6450	6020	11180	11997	11210	140/147	21	150/157	27	152.4 x 3.0/4.0/5.0
6-55	55	7700	8250	7700	14300	15345	14339	160/167	26	150/157	21	168.3 x 3.0/4.0

1) Flat ducts possible as well

2) Flat duct PT-PLUS with rectangular slab anchorages, for PT-PLUS see also under 3.1.3.

3) If flat ducts (steel or PT PLUS) to be used with square type castings please contact your VSL representative. In plan view, tendons with slab type anchorages must be straight between anchorages or have only unidirectional turns with min. radii of > 6 m. Strands must always be pushed-in prior to concreting. Eccentricity e: negligible

4) Given values may slightly vary depending on local availability of ducts. They are minimal for most applications. For special cases (long tendons, many curvatures, small radii etc.) greater size duct is recommended – please verify with VSL. In any case the filling ratio (cross-section steel / duct) must not exceed 0.5 (EN523).

5) Please check with the nearest VSL office for the complete anchorage list

2 - ANCHORAGES

For the selection and the dimensions of the most commonly used anchorages, please consult the VSL data sheets on anchorages. For spacing between anchorages and edge distance, refer to individual anchorage data sheet.

3 - DUCTING

3.1 TYPES

3.1.1 Bright corrugated steel ducts

The most commonly used sheaths are made from rolled steel strip. Round and flat (max. 5 strands are available). They are corrugated and leak-tight and must have sufficient strength to withstand varying degrees and types of mechanical loading. For additional information and details, locally valid norms (or for example EN523) can be consulted.

3.1.2 Galvanized corrugated steel ducts

Galvanization is sometimes used to ensure corrosion protection of the metal strip. It can provide lower friction losses when stressing the tendon.

Please check local code requirements.

3.1.3 Corrugated PT-PLUS® duct system

For enhanced corrosion protection and fatigue resistance of the tendons, use of the VSL PT-PLUS® corrugated plastic duct system is

recommended. The PT-PLUS® system is particularly suitable for railroad bridges, bridge decks, parking structures and other situations where severe corrosion or high fatigue loading may be expected. In addition, the PT-PLUS® system with additional details at the anchorages allows to provide electrically isolated tendons (EIT) and a protection level of

PL3 (*fib* bulletin 33). These EIT tendons permit monitoring of the leak tightness of the tendon encapsulation and protection of the tendon over the entire design life of the structure.

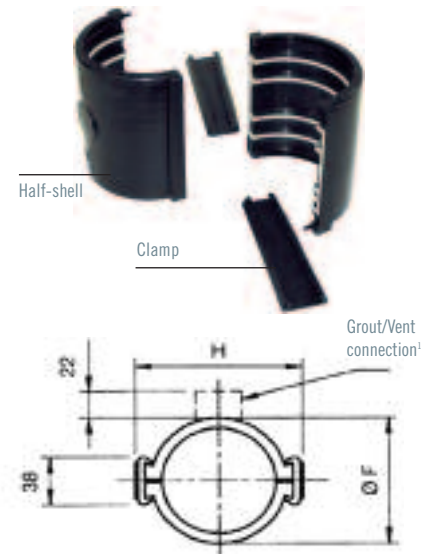

¹ Couplers are available with grout / vent connections for a threaded tube with dia. 23 mm

Dimensions for PT-PLUS® duct system

Dimensions in mm, subject to modifications

Type	Tendon unit		Ø A	Ø B	Ø C	D	E	Ø F	G	H	Nominal weight	
	0.5"	0.6"									Duct kg/m	Coupler kg/unit
22	5-1	6-1	22	25	31	1.5	55	27.5 ²	80 ²	27.5 ²	0.180	0.010
59	5-12	6-7	58	63	73	2.5	42	82	108	106	0.480	0.200
76	5-19	6-12	76	81	91	2.5	52.5	100	116	124	0.620	0.250
100	5-31	6-19/22	100	106	116	3.0	60	123	126	147	0.980	0.270
115	5-37	6-27	115	121	131	3.0	60	138	127	162	1.120	0.320
130	5-43/55	6-31/37	130	136	146	3.0	52	153	134	177	1.200	0.380
150		6-55	150	157	167	3.5	60	175	126	198	1.620	0.420

¹ One-piece sleeve coupler

Note: PT-PLUS ducts come in lengths of approximately 6 m, type 22 ducts are 7 m long

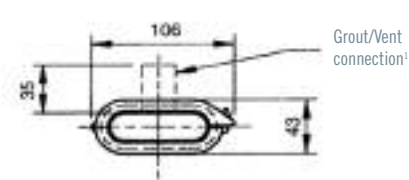
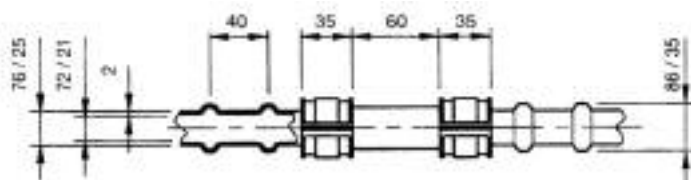
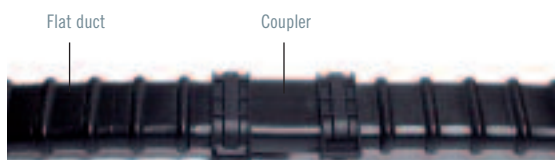

Dimensions in mm, subject to modifications

¹ Couplers are also available with grout / vent connections for a smooth tube with dia. 16 / 20 mm.

The PT-PLUS® flat duct system and type 22 are often used for slab post-tensioning in buildings, for transversal tendons for bridges and for similar structures where the exploitation of a maximum tendon eccentricity in relatively thin members is important.

3.1.4 Smooth plastic ducts

Smooth plastic ducts are predominantly used for external tendons. Occasionally they have been also used for internal tendons when no bonding steel / concrete is required. They are normally made of UV resistant, new high density polyethylene (HDPE) material (virgin granulate) acc. to EN12201 and ASTM D3035 or ASTM F714 or equivalent standards. Material recycled from previously used PE components shall not

be used. Ducts normally have a ratio of diameter / wall thickness of 16 to 18, with an internal diameter not smaller than $1.7\sqrt{A_p}$ (A_p = nominal cross section of the steel area in the tendon), suitable to carry internal pressure during grouting (ETAG013 (2002) e.g. specifies 1 MPa / 10 bar design pressure). The following dimensions of external tendon pipes are recommended (see table below).

3.1.5 Steel pipes

In certain applications (e.g. cryogenic, nuclear, offshore) where the ducts are subject to high loading when particularly tight tendon curvature is required, or when tendons are in congested parts of structures, steel pipes are used. Tubes are thin (in compliance with EN or equivalent

standards) and machine-bendable, recommended dimensions see 1.2 / 1.4. Steel tubes used externally: dimensions are primarily dictated by the availability of local standardized tubes. The table below can serve as a guideline and is based on an internal diameter of $\geq 1.7\sqrt{A_p}$ where A_p represents the cross section of the prestressing steel, irrespective of whether the strand is bare or sheathed and greased.

Dimensions for steel pipes

Strand Nos.	Min inside dia. for strands with		
	100 mm ²	140 mm ²	150 mm ²
4	34	40.2	41.6
7	45	53.2	55.1
12	58.9	69.7	72.1
15	65.8	77.9	80.6
19	74.1	87.7	90.8
22	79.7	94.3	97.7
27	88.3	104.5	108.2
31	94.7	112.0	115.9
37	103.4	122.4	126.6
43	111.5	131.9	136.5
55	126.1	149.2	154.4

Dimensions in mm, subject to modifications

*Wall thickness $e \geq \phi / 50$ or minimum 1.5 mm
 ϕ = external diameter*

Where steel pipes need to be welded, $e \geq 3$ mm

Dimensions for smooth plastic ducts

Tendon size	External pipe diameter (mm)		Wall thickness (mm)	
	strands		strands	
	bare	PE sheathed	bare	PE sheathed
5-12 / 6-7	75	90	4.3	5.1
5-15/19 / 6-12	90	110	5.4	6.0
5-22/31 / 6-15/19	110	140	6.6	6.7
5-37 / 6-22/27	125	160	7.7	7.7
5-43 / 6-31	140	160	8.3	7.7
5-55 / 6-37	160	180	9.5	8.6

Dimensions in mm, subject to modifications

3.2 FRICTION COEFFICIENT AND LOSSES DUE TO PRESTRESSING

3.2.1 Friction coefficient

The following values may be assumed when using the equation $P_x = P_0 e^{-(\mu\phi_x + kx)}$:

Equation of loss of post-tensioning force along a tendon

P_x = Remaining force at distance x from the stressing end	$\mu\phi_x$ = Accumulated tendon deviation from the stressing end
P_0 = Stressing force at the stressing end	k = Wobble coefficient
μ = Friction coefficient	x = Distance from the stressing end

	Range	Recommended value
Corrugated Steel Sheath	$\mu = 0.16 - 0.24$ $k = (0.6 - 1.0) \times 10^{-3} \text{ m}^{-1}$	$\mu = 0.20$ $k = 0.8 \times 10^{-3} \text{ m}^{-1}$
PT-PLUS® Plastic Duct	$\mu = 0.12 - 0.14$ $k = (0.8 - 1.2) \times 10^{-3} \text{ m}^{-1}$	$\mu = 0.14$ $k = 1.0 \times 10^{-3} \text{ m}^{-1}$
Steel pipes incl. saddles for external tendons: with clean dry or lubricated strands ¹	$\mu = 0.20 - 0.30$ $k = \text{refer to 2 below}$	$\mu = 0.25$ $k = \text{refer to 2 below}$
Saddles for external tendons with internal HDPE tube over saddle: - bare strands - greased and plastic sheathed monostrands	$\mu = 0.12 - 0.15$ $\mu = 0.02 - 0.08$ $k = \text{refer to 2 below}$	$\mu = 0.14$ $\mu = 0.06$ $k = \text{refer to 2 below}$
Greased and plastic sheathed monostrands	$\mu = 0.04 - 0.07$ $k = (0.4 - 0.6) \times 10^{-3} \text{ m}^{-1}$	$\mu = 0.05$ $k = 0.5 \times 10^{-3} \text{ m}^{-1}$

¹. μ -values depend on lubrication

². The wobble factor can normally be neglected

3.2.2 Draw-in of wedge at lock-off: approx. 6 mm

This value is independent of the jack or tendon type. If necessary, e.g. for short tendons, compensation can be provided by appropriate procedures.

3.2.3 Other tendon force losses

In addition to friction and relaxation losses (see above), also concrete shrinkage and creep as well as a draw-in of the wedge during lock-off must be considered.

To calculate losses due to concrete shrinkage and creep, reference should be made to the technical documents and standards applicable to each project.

3.3 DUCT SPACING AND COVER

The cable layout patterns are dictated by the designer.

When detailing that cable layout, it is absolutely essential to consider the spacing of cables from

one another, required cover, and radii of curvature. Usually the spacing and curvatures are laid down in standards, guidelines or national approvals. If not available, VSL recommends that the following guidance values be observed, these being minimum values:

Minimum spacing and cover of duct

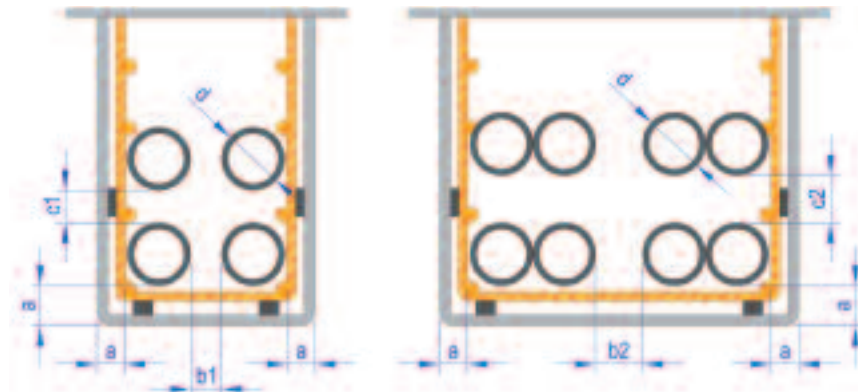

Measurement (a)

- Precast elements, elements protected from bad weather, soft environmental conditions 30
- In general 40
- Severe environmental conditions 50

SPACING

- b1, c1 = 0.7 times diameter of the duct
- b2, c2 = 1.0 times diameter of the duct

3.4 SPACING OF THE SUPPORTS AND TOLERANCES

The spacing of the supports underneath steel and plastic ducts must be 10 to 12 times the internal diameter of the duct. Kinks are not permitted.

The fastening fittings must be sufficiently robust and close enough such that the ducts and tendons will not exhibit displacements or deformations in excess of the allowed tolerances. For tolerances on cable positions reference should be made to applicable standards and recommendations.

Moreover, under all circumstances and in every direction, whenever a cable displays or potentially displays deviation in the vicinity of an edge of concrete which could lead to spalling of concrete cover, an offset with respect to the theoretical axis is only tolerated provided that equilibrium reinforcing bars have been provided over this zone.

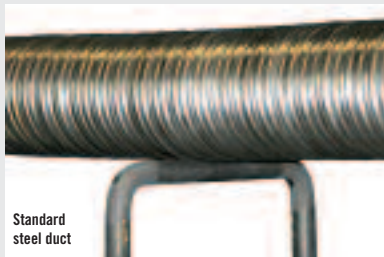

Standard steel duct

In determining minimum spacings and concrete cover requirements for ducts, reference should be made to applicable standards and recommendations, see 3.3.

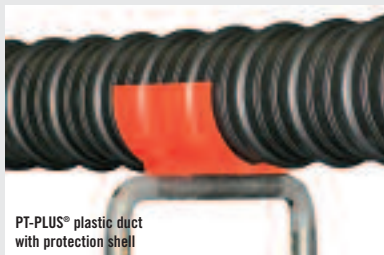

PT-PLUS® plastic duct with protection shell

VSL Protection shells are recommended to be fixed on the duct at tendon supports for tendon radii $R < 2 R_{min}$ (see under 4.2), and where ducts risk to be dented by closely placed rebars.

3.5 SADDLES FOR EXTERNAL TENDON

3.5.1 Saddles

Various solutions are used in practice. In most cases, saddles consist of a pre-bent steel tube cast into the surrounding concrete or attached to a steel structure by stiffening plates. The connection between the free tendon length and

the saddle must be carefully detailed in order not to damage the prestressing steel by sharp angular deviations during stressing and in service. It is also important that the protective sheath be properly joined. If tendon replacement is a design requirement, the saddle arrangement must be chosen accordingly.

3.5.2 Various saddle arrangements

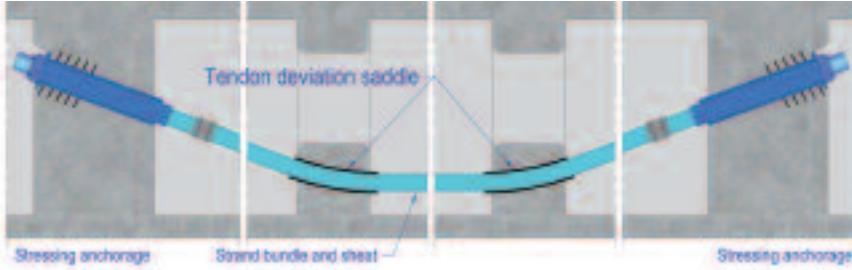

PE pipe through bell-mouth deviator, from anchorage to anchorage (most common detail)

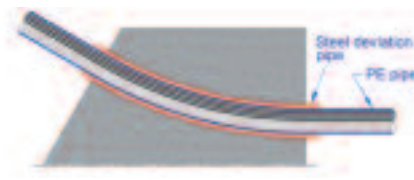

PE pipe through deviator pipe, from anchorage to anchorage



Deviation pipe protrudes from concrete at sufficient distance and is coupled to PE pipe

4 - DESIGN REQUIREMENTS

4.1 ANCHORAGE ZONE REINFORCEMENT

The transfer of the prestressing forces from the anchorage into the concrete produces stresses which exceed the concrete strength and that must be withstood by special reinforcement. A distinction may be made between three types of reinforcement.

a) Local zone reinforcement in the immediate vicinity of the anchorage

For this purpose, spirals (helices) or appropriate orthogonal reinforcement are normally used. This reinforcement is considered as an integral component of the anchorage and its design lies

within the field of responsibility of VSL. This reinforcement is specified in approvals and it may only be changed upon approval by VSL. The Anchorage data sheets show the required reinforcement for each anchorage.

b) General zone of reinforcement for resisting the spreading of forces in the structure

This reinforcement is designed by the project designer. Guidelines for its design can be found in VSL's report "Detailing for post-tensioning".

c) Reinforcement for spalling forces near stress free edges

3.5.3 Minimum radius of tendon curvature for external tendons

Tendon unit		Minimum radius
0.5"	0.6"	
up to 5 - 12	6 - 7	2.00 m
up to 5 - 19	6 - 12	2.50 m
up to 5 - 31	6 - 22	3.00 m
up to 5 - 43	6 - 31	3.50 m
up to 5 - 55	6 - 37	4.00 m
up to	6 - 43	4.50 m
up to	6 - 55	5.00 m

- The values are equivalent to approximately $R_{min} (m) = (1.5 \text{ to } 1.3) \sqrt{F_{pk} [MN]} \geq 2.0 \text{ m}$

- They apply to smooth steel and HDPE pipe and assume a straight length on either side of the deviation.



Diabolo bell-mouth for deviation points at diaphragm segment

4.2 MINIMUM RADIUS OF TENDON CURVATURE AND TANGENT LENGTH FOR INTERNAL TENDONS

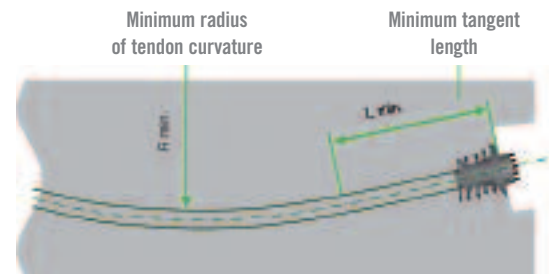

$$R_{min} (m) = 3.0 \times \sqrt{F_{pk} [MN]} \geq 2.5 \text{ m}$$

$$L_{min} = 0.8 \text{ m for } F_{pk} \leq 2 \text{ MN}$$

$$= 1.0 \text{ m for } F_{pk} \geq 2 \text{ MN, } \leq 7 \text{ MN}$$

$$= 1.5 \text{ m for } F_{pk} \geq 7 \text{ MN}$$

$$R_{min} (m) = 2.50 \text{ m for unbonded tendons for 5-1 and 6-1}$$

5 - INSTALLATION

5.1 ANCHORAGES

It is a requirement that the bearing plate / casting of anchorages are fixed perpendicular to the tendon axis.

The block-out dimensions and clearance requirement as given under 5.3 should be followed. Departures from these data may be possible. Please contact VSL.

5.2 GROUT VENTS

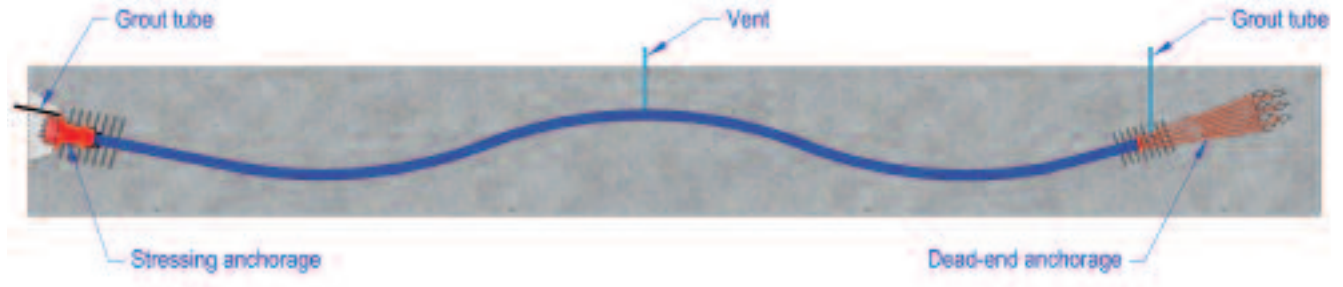

Low point drains should only be foreseen where there is a risk of water freezing inside the duct and hence, drainage is required. As a general rule distance between grout connections should not exceed 100 m. They should have a range of spacing between vents in the order of 30 – 70 m.

5.3 BLOCK-OUT DIMENSIONS AND CLEARANCE REQUIREMENTS

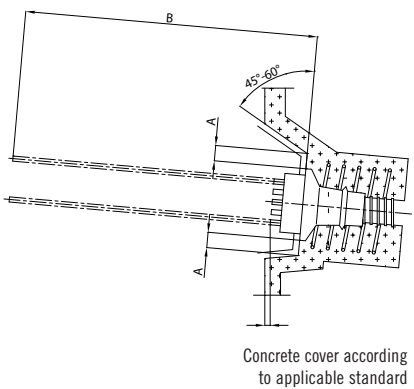

Jack type	A min.	B	C	D	E
ZPE-23FJ	–	300-360	1,200	116	90
ZPE-30	30	600	1,350	140	100
ZPE-3	30	500	1,000	200	150
ZPE-60	30	650	1,250	180	140
ZPE-7/A	30	650	1,400	300	200
ZPE-12/St2	50	520	1,100	310	200
ZPE-185*	50	620	1,220	300	180
ZPE-200	50	950	2,000	330	210
ZPE-19	50	700	1,500	390	250
ZPE-460/31	60	560	1,300	485	300
ZPE-500	80	950	2,000	585	330
ZPE-580*	80	860	1,620	500	280
ZPE-750	80	1,200	2,400	570	365
ZPE-980*	80	950	1,760	650	360
ZPE-1000	80	1,200	2,400	790	450
ZPE-1250	90	1,300	2,550	710	375
ZPE-1450*	90	1,010	1,850	770	420

*Jack is designed to be used for 310kN UTS strands stressed to max. 85% of the 310kN.

Dimensions in mm

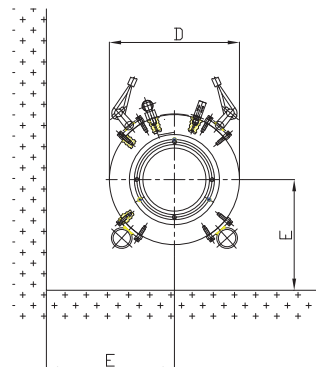
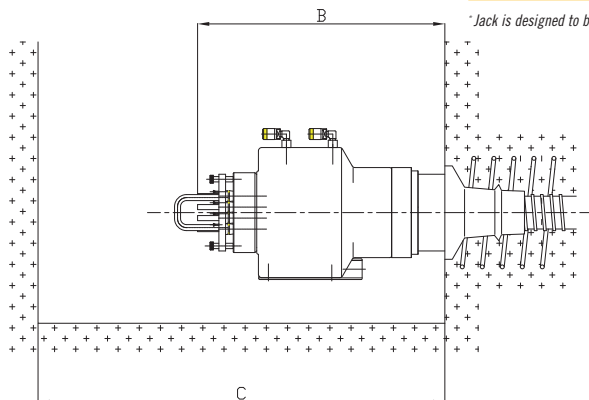

5.4 STRESSING JACK DATA



Type I (ZPE-23FJ)



Type II (ZPE-460/31)



Type III (ZPE-1000)

Designation	ZPE-23FJ	ZPE-30	ZPE-3	ZPE-60	ZPE-7/A	ZPE-12/St2	ZPE-185*	ZPE-200	ZPE-19
Type	I	II	III	III	III	II	II	III	II
Length (mm)	830	720	475	615	700	610	600	1,170	730
Diameter (mm)	116	140	200	180	280	310	295	315	390
Stroke (mm)	200	250	160	250	160	100	100	300	100
Piston area (cm ²)	47.10	58.32	103.6	126.4	203.6	309.4	309.3	325.7	500.3
Capacity (kN)	230	320	500	632	1,064	1,850	1,856	2,000	2,900
(bar)	488	549	483	500	523	600	600	614	580
Weight (kg)	23	28	47	74	140	151	120	305	294
Used for 13mm/ 0.5" tendon types	5-1	5-1	5-2 5-3	5-2 to 5-4	5-6 5-7	5-12	5-7	5-12 5-19	5-18
Used for 15mm/ 0.6" tendon types	6-1	6-2	6-2	6-2 6-3	6-4	6-6 6-7	6-3 6-4 6-7	6-6 6-7	6-12

Designation	ZPE-460	ZPE-500	ZPE-580*	ZPE-750	ZPE-980*	ZPE-1000	ZPE-1250	ZPE-1450*
Type	II	III	II	II	II	III	II	II
Length (mm)	580	1,000	760	1,185	810	1,150	1,290	840
Diameter (mm)	485	550	500	520	645	790	620	765
Stroke (mm)	100	200	150	150	150	200	150	150
Piston area (cm ²)	804.0	894.6	961.7	1,247.0	1,652.3	1,809.5	2,168.0	2,436.9
Capacity (kN)	4,660	5,000	5,805	7,500	9,750	10,000	12,500	14,500
(bar)	580	559	610	601	590	553	577	595
Weight (kg)	435	1,064	460	1,100	800	2,340	1,730	1,250
Used for 13mm/ 0.5" tendon types	5-22 5-31	5-22 5-31	5-12 to 5-31	5-31 to 5-55		5-37 to 5-55	5-37	
Used for 15mm/ 0.6" tendon types	6-18 6-19	6-18 to 6-22	6-12 6-19 6-22	6-31 to 6-43	6-27 6-31 6-37	6-31 to 6-37	6-43 to 6-55	6-43 6-48 6-55

* Jack is designed to be used for 310kN UTS strands stressed to max. 85% of the 310kN.

VSL LOCATIONS

www.vsl.com

HEADQUARTERS

VSL International Ltd.
Scheibenstrasse 70 – Bern
CH-3014 – Switzerland
Phone: +41 58 456 30 00
Fax: +41 58 456 30 95

Americas

ARGENTINA

VSL Sistemas Especiales de
Construcción Argentina SA
BUENOS AIRES
Phone: +54 11 4326 06 09
Fax: +54 11 4326 26 50

BOLIVIA

Postensados de Bolivia
San Miguel, LA PAZ
Phone: +591 2 27 70 338
Fax: +591 2 27 96 183

CHILE

VSL Sistemas Especiales de
Construcción S.A.
SANTIAGO
Phone: +56 2 571 67 00
Fax: +56 2 571 67 01

COLOMBIA

Sistemas Especiales de Construcción Ltda.
BOGOTA
Phone: +57 1 620 96 34
Fax: +57 1 620 58 16

MEXICO

VSL Corporation Mexico S.A de C.V
MEXICO
Phone: +52 55 55 11 20 36
Fax: +52 55 55 11 40 03

PERU

Sistemas Especiales de Construcción Peru S.A.
LIMA
Phone: +51 1 349 38 38
Fax: +51 1 348 28 78

UNITED STATES

VStructural LLC
BALTIMORE, MD
Phone: +1 410 850 7000
Fax: +1 410 850 4111

VENEZUELA

Gestión de Obras y Construcciones C.A.
CARACAS
Phone/Fax: +58 212 941 86 75

Africa

EGYPT

Matrix Engineering Company
CAIRO
Phone: +20 2 344 19 00
Fax: +20 2 346 04 57

SOUTH AFRICA

Tsala-RMS Construction Solutions (Pty) Ltd
JOHANNESBURG
Phone: +27 11 878 6820
Fax: +27 11 878 6821

Europe

AUSTRIA

Grund-Pfahl- und Sonderbau GmbH
HIMBERG
Phone: +43 2235 87 777
Fax: +43 2235 86 561

CROATIA

Tehnički projekt d.o.o.
10000 Zagreb
Phone: +385 1 4664 586
Fax: +385 1 4664 549

CZECH REPUBLIC

VSL Systems (CZ) Ltd.
PRAGUE
Phone: +420 2 51 09 16 80
Fax: +420 2 51 09 16 99

FRANCE

VSL France S.A.
LABÈGE
Phone: +33 05 61 00 96 59
Fax: +33 05 61 00 96 62

GERMANY

VSL Systems GmbH
BERLIN
Phone: +49 30 530 28 06-0
Fax: +49 30 530 28 06-99

GREAT BRITAIN

VSL Systems (UK) Ltd.
BEDFORDSHIRE
Phone: +41 58 456 30 30
Fax: +41 58 456 30 35

NETHERLANDS

Heijmans Beton en Waterbouw B.V.
ROSMALEN
Phone: +31 73 543 66 02
Fax: +31 73 543 66 11

NORWAY

SPENNARMERING NORGE AS
STAVANGER
Phone: +47 91 10 33 18
Fax: +47 51 41 94 80

PORTUGAL

VSL Sistemas Portugal
Pre-Esforço, Equipamento
e Montagens S.A.
S. DOMINGOS DE RANA
Phone: +351 21 445 83 10
Fax: +351 21 444 63 77

VSL GEO

Sistemas de Aplicação em Geotecnia SA
S. DOMINGOS DE RANA
Phone: +351 21 445 83 10
Fax: +351 21 445 83 28

SPAIN

CTT Stronghold
BARCELONA
Phone: +34 93 289 23 30
Fax: +34 93 289 23 31

VSL-SPAM, S.A.

BARCELONA
Phone: +34 93 846 70 07
Fax: +34 93 846 51 97

SWEDEN/NORWAY

Internordisk Spännarmring AB
VÄSTERHANINGE
Phone: +47 98 21 02 66
Fax: +47 67 17 30 01

SWITZERLAND

VSL (Switzerland) Ltd.
SUBINGEN
Phone: +41 58 456 30 30
Fax: +41 58 456 30 35

VSL (Suisse) SA

SAINT LEGIER
Phone: +41 58 456 30 00
Fax: +41 58 456 30 95

TURKEY

Mega Yapi Construction & Trade Co. Ltd
ANKARA
Phone: +90 312 490 90 66
Fax: +90 312 490 90 55

Middle East

UNITED ARAB EMIRATES

VSL Middle East LLC
DUBAI, UAE
Phone: +971 4 885 7225
Fax: +971 4 885 7226

Asia

BRUNEI

VSL Systems (B) Sdn. Bhd.
BRUNEI DARUSSALAM
Phone: +673 2 380 153 / 381 827
Fax: +673 2 381 954

CHINA PRC

VSL (China) Engineering Corp., Ltd.
HEFEI
Phone: +86 551 382 29 18
Fax: +86 551 382 28 78

HONG KONG

VSL Hong Kong Ltd.
CHAI WAN
Phone: +852 2590 22 88
Fax: +852 2590 02 90

Intrafor Hong Kong Ltd.

CHAI WAN
Phone: +852 2836 31 12
Fax: +852 2591 61 39

FT Laboratories Ltd.

PING CHE
Phone: +852 2758 48 61
Fax: +852 2758 89 62

INDIA

VSL India PVT Ltd.
CHENNAI
Phone: +91 44 4225 11 11
Fax: +91 44 4225 10 10

INDONESIA

PT VSL Indonesia
JAKARTA
Phone: +62 21 570 07 86
Fax: +62 21 573 75 57

JAPAN

VSL Japan Corporation
TOKYO
Phone: +81 3 3346 8913
Fax: +81 3 3345 9153

KOREA

VSL Korea Co. Ltd.
SEOUL
Phone: +82 2 553 8200
Fax: +82 2 553 8255

MALAYSIA

VSL Engineers (M) Sdn. Bhd.
KUALA LUMPUR
Phone: +603 7981 47 42
Fax: +603 7981 84 22

PHILIPPINES

VSL Philippines Inc.
PASIG CITY
Phone/Fax: +632 723 13 95

SINGAPORE

VSL Singapore Pte. Ltd.
SINGAPORE
Phone: +65 6559 12 22
Fax: +65 6257 77 51

TAIWAN

VSL Taiwan Ltd.
TAIPEI
Phone: +886 2 2759 6819
Fax: +886 2 2759 6821

THAILAND

VSL (Thailand) Co. Ltd.
BANGKOK
Phone: +66 2 679 76 15 - 19
Fax: +66 2 679 76 45

VIETNAM

VSL Vietnam Ltd.
HANOI
Phone: +84 4 3976 5088
Fax: +84 4 3976 5089

Ho Chi Minh City

Phone: +84 8 810 6817
Fax: +84 8 810 6818

Australia

VSL Australia Pty. Ltd.

NEW SOUTH WALES
Phone: +61 2 9484 5944
Fax: +61 2 9875 3894

QUEENSLAND

Phone: +61 7 3265 64 00
Fax: +61 7 3265 75 34

VICTORIA

Phone: +61 3 979 503 66
Fax: +61 3 979 505 47

SOUTH AUSTRALIA

Phone: +61 8 8354 4884
Fax: +61 8 8354 4883

TASMANIA

Phone: +61 3 6225 3567
Fax: +61 3 6225 2226

PERTH

Phone/Fax: +61 8 9523 4686

Copyright 2009, VSL International Ltd.
Printed in France – patented.

The information set forth in this brochure including technical and engineering data is presented for general information only. While every effort has been made to insure its accuracy, this information should not be used or relied upon for any specific application without independent professional examination and verification of its accuracy, suitability and applicability. Anyone using this material assumes any and all liability resulting from such use. VSL disclaims any and all express or implied warranties of merchantability fitness for any general or particular purpose or freedom from infringement of any patent, trademark, or copyright in regard to the information or products contained or referred to herein. Nothing herein contained shall be construed as granting a license, express or implied under any patents.